

thickness of the ceiling
Stärke der Decke

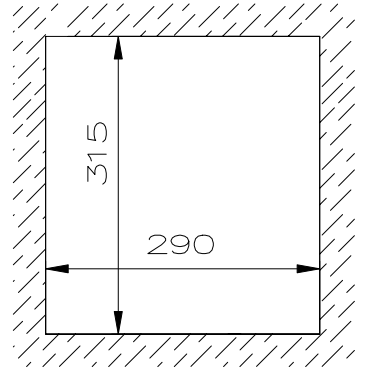
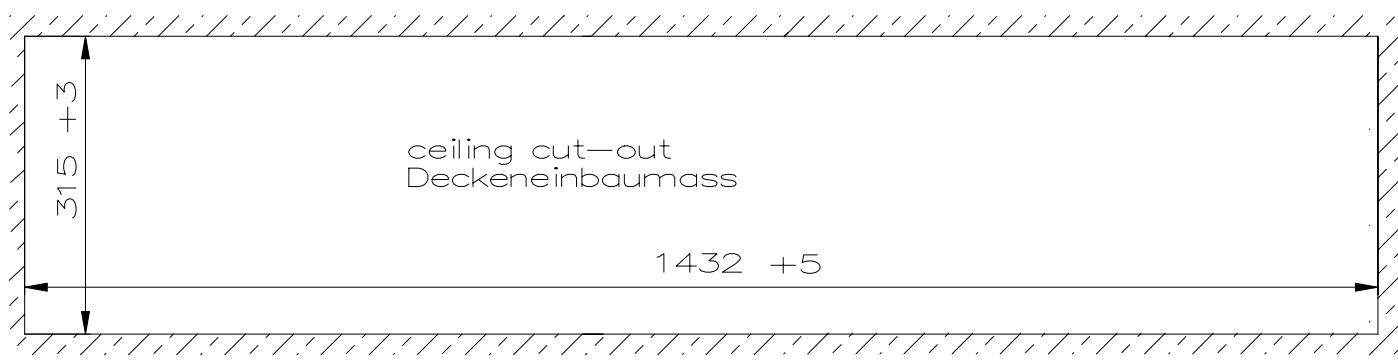
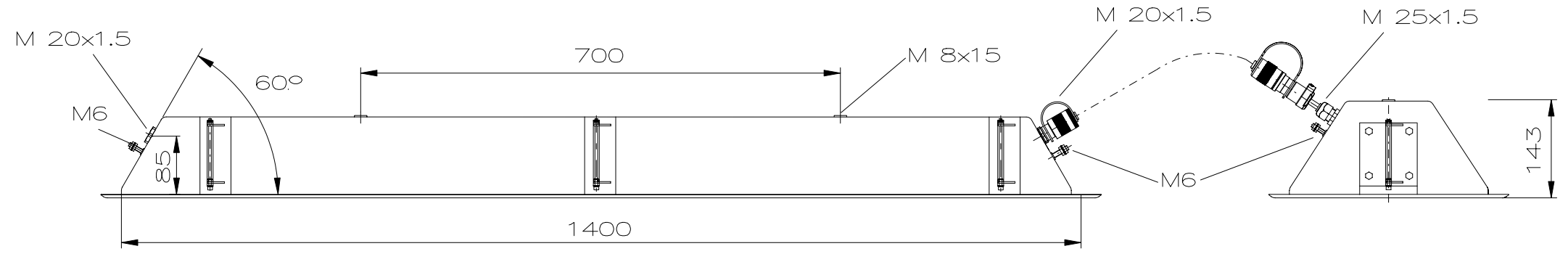
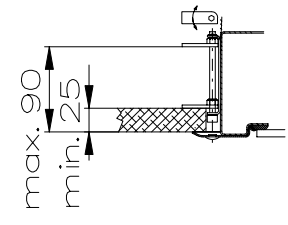

"Schutzvermerk nach DIN 34 beachten" / "Copyright reserved"

Description: Ex-recessed ceiling emergency light fitting eLLB 20 36/36 NIB 2/6-2, Stainless Steel 316

Beschreibung: Ex-Deckeneinbaunotleuchte eLLB 20 36/36 NIB 2/6-2, Edelstahl 316



Rev.st/ Zust.	Revision/ Änderung	Date/ Datum	Name/ Name

Date/ Datum	14.07.2008
Expert/ Bearbeiter	Röther
Scale	1:8
Dimension unit: mm Maßeinheit: mm	

Material-No.:/ Material-Nr.:
12190236012