

| eXLink 4-pole |

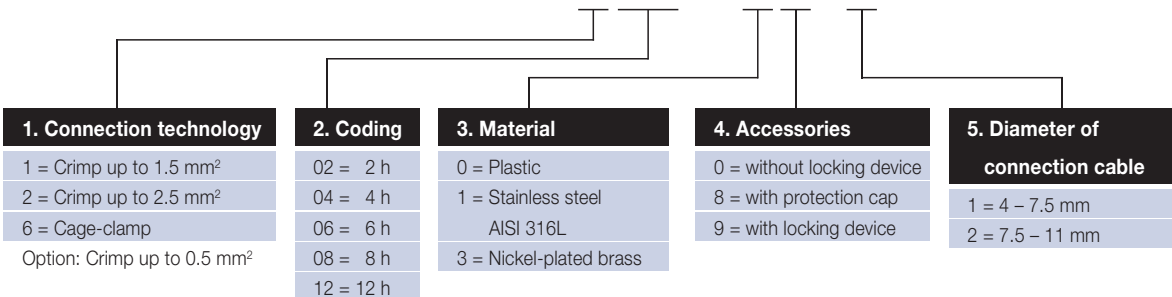

Ordering key eXLink plug 4-pole

GHG 571 7XXX RXX0X



Ordering details

Voltage	No. of poles	Coding	Connection	Diameter of connection cable	
				4 – 7.5 mm Order No.	7.5 – 11 mm Order No.
Plug made of plastic					
BUS	3-pol + PA	2 h	Crimp up to 1.5 mm ²	GHG 571 7102 R0001	GHG 571 7102 R0002
BUS	3-pol + PA	2 h	Cage clamp	GHG 571 7602 R0001	GHG 571 7602 R0002
110 V AC	2-pol + PE	4 h	Crimp up to 1.5 mm ²	GHG 571 7104 R0001	GHG 571 7104 R0002
110 V AC	2-pol + PE	4 h	Crimp up to 2.5 mm ²	GHG 571 7204 R0001	GHG 571 7204 R0002
110 V AC	2-pol + PE	4 h	Cage clamp	GHG 571 7604 R0001	GHG 571 7604 R0002
230 V AC	2-pol + PE	6 h	Crimp up to 1.5 mm ²	GHG 571 7106 R0001	GHG 571 7106 R0002
230 V AC	2-pol + PE	6 h	Crimp up to 2.5 mm ²	GHG 571 7206 R0001	GHG 571 7206 R0002
230 V AC	2-pol + PE	6 h	Cage clamp	GHG 571 7606 R0001	GHG 571 7606 R0002
24 V DC	4-pol	2 h	Crimp up to 1.5 mm ²	GHG 571 7108 R0001	GHG 571 7108 R0002
24 V DC	4-pol	2 h	Crimp up to 2.5 mm ²	GHG 571 7208 R0001	GHG 571 7208 R0002
Plug made of nickel-plated brass					
BUS	3-pol + PA	2 h	Crimp up to 1.5 mm ²	GHG 571 7102 R3001	GHG 571 7102 R3002
BUS	3-pol + PA	2 h	Cage clamp	GHG 571 7602 R3001	GHG 571 7602 R3002
110 V AC	2-pol + PE	4 h	Crimp up to 1.5 mm ²	GHG 571 7104 R3001	GHG 571 7104 R3002
110 V AC	2-pol + PE	4 h	Crimp up to 2.5 mm ²	GHG 571 7204 R3001	GHG 571 7204 R3002
110 V AC	2-pol + PE	4 h	Cage clamp	GHG 571 7604 R3001	GHG 571 7604 R3002
230 V AC	2-pol + PE	6 h	Crimp up to 1.5 mm ²	GHG 571 7106 R3001	GHG 571 7106 R3002
230 V AC	2-pol + PE	6 h	Crimp up to 2.5 mm ²	GHG 571 7206 R3001	GHG 571 7206 R3002
230 V AC	2-pol + PE	6 h	Cage clamp	GHG 571 7606 R3001	GHG 571 7606 R3002
Plug made of stainless steel					
BUS	3-pol + PA	2 h	Crimp up to 1.5 mm ²	GHG 571 7102 R1001	GHG 571 7102 R1002
BUS	3-pol + PA	2 h	Cage clamp	GHG 571 7602 R1001	GHG 571 7602 R1002
110 V AC	2-pol + PE	4 h	Crimp up to 1.5 mm ²	GHG 571 7104 R1001	GHG 571 7104 R1002
110 V AC	2-pol + PE	4 h	Crimp up to 2.5 mm ²	GHG 571 7204 R1001	GHG 571 7204 R1002
110 V AC	2-pol + PE	4 h	Cage clamp	GHG 571 7604 R1001	GHG 571 7604 R1002
230 V AC	2-pol + PE	6 h	Crimp up to 1.5 mm ²	GHG 571 7106 R1001	GHG 571 7106 R1002
230 V AC	2-pol + PE	6 h	Crimp up to 2.5 mm ²	GHG 571 7206 R1001	GHG 571 7206 R1002



Ordering key eXLink plug 4-pole + PE

GHG 574 7XXX RXX0X

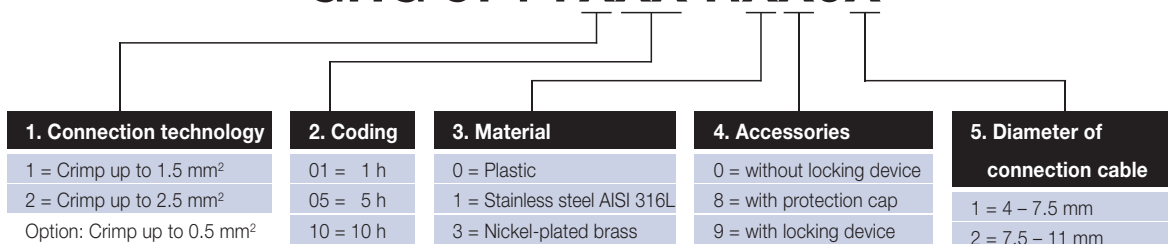

Ordering details

Voltage	No. of poles	Coding	Connection	Diameter of connection cable	
				4 – 7,5 mm Order No.	7,5 – 11 mm Order No.

Plug made of plastic version

Ethernet/Bus	4 pol + PA	1 h	Crimp up to 1.5 mm ²	GHG 574 7101 R0001	GHG 574 7101 R0002
24 V DC	4 pol + PE	5 h	Crimp up to 1.5 mm ²	GHG 574 7105 R0001	GHG 574 7105 R0002
24 V DC	4 pol + PE	5 h	Crimp up to 2.5 mm ²	GHG 574 7205 R0001	GHG 574 7205 R0002
230 V AC	4 pol + PE	10 h	Crimp up to 1.5 mm ²	GHG 574 7110 R0001	GHG 574 7110 R0002
230 V AC	4 pol + PE	10 h	Crimp up to 2.5 mm ²	GHG 574 7210 R0001	GHG 574 7210 R0002

Plug made of nickel-plated brass

Ethernet/Bus	4 pol + PA	1 h	Crimp up to 1.5 mm ²	GHG 574 7101 R3001	GHG 574 7101 R3002
24 V DC	4 pol + PE	5 h	Crimp up to 1.5 mm ²	GHG 574 7105 R3001	GHG 574 7105 R3002
24 V DC	4 pol + PE	5 h	Crimp up to 2.5 mm ²	GHG 574 7205 R3001	GHG 574 7205 R3002
230 V AC	4 pol + PE	10 h	Crimp up to 1.5 mm ²	GHG 574 7110 R3001	GHG 574 7110 R3002
230 V AC	4 pol + PE	10 h	Crimp up to 2.5 mm ²	GHG 574 7210 R3001	GHG 574 7210 R3002

Plug made of stainless steel

Ethernet/Bus	4 pol + PA	1 h	Crimp up to 1.5 mm ²	GHG 574 7101 R1001	GHG 574 7101 R1002
24 V DC	4 pol + PE	5 h	Crimp up to 1.5 mm ²	GHG 574 7105 R1001	GHG 574 7105 R1002
24 V DC	4 pol + PE	5 h	Crimp up to 2.5 mm ²	GHG 574 7205 R1001	GHG 574 7205 R1002
230 V AC	4 pol + PE	10 h	Crimp up to 1.5 mm ²	GHG 574 7110 R1001	GHG 574 7110 R1002
230 V AC	4 pol + PE	10 h	Crimp up to 2.5 mm ²	GHG 574 7210 R1001	GHG 574 7210 R1002

Cooper Crouse-Hinds © 2009 - all rights reserved

1
2
3
4
5
6
7
8
9
10
11
12

| eXLink 4-pole/4-pole + PE |

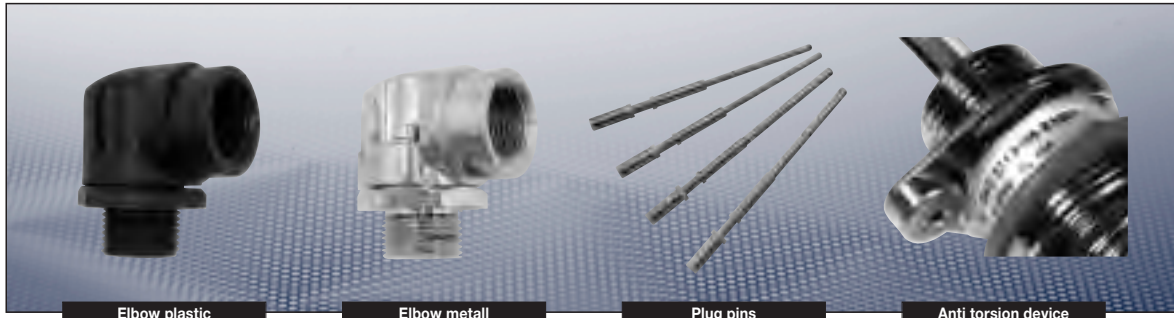

Ordering key eXLink elbow

GHG 571 1000 RX001

Material
0 = Plastic
1 = Stainless steel AISI 316L
3 = Nickel-plated brass

Ordering details

Type	Material	Order No.
Elbow M20	Plastic	GHG 571 1000 R0001
Elbow M20	Stainless steel AISI 316L	GHG 571 1000 R1001
Elbow M20	Nickel-plated brass	GHG 571 1000 R3001

Accessories

Type	BE	Version			Order No.
		3+PE	4 pol.	4+PE	
Set of socket contacts 0.5 mm ² , 4-pole	1	X	X	–	GHG 570 1905 R0007
Set of socket contacts 1.5 mm ² , 4-pole	1	X	X	–	GHG 570 1905 R0001
Set of socket contacts 2.5 mm ² , 4-pole	1	X	X	–	GHG 570 1905 R0002
Set of socket contacts 1.5 mm ² , 4-pole + PE contact	1	–	–	X	GHG 570 1905 R0003
Set of socket contacts 2.5 mm ² , 4-pole + PE contact	1	–	–	X	GHG 570 1905 R0004
Crimp tool for eXLink	1	X	X	X	GHG 570 1902 R0001
Plastic protection cap connector/receptacle	1	X	X	X	GHG 570 1903 R0001
Plastic protection cap plug/inlet	1	X	X	X	GHG 570 1903 R0002
Brass protection cap connector/receptacle	1	X	X	X	GHG 570 1903 R0003
Brass protection cap plug/inlet	1	X	X	X	GHG 570 1903 R0004
Set of plug pins 0.5 mm ² , 3-pole + PE (PE leading AC)	1	X	–	–	GHG 570 1904 R0012
Set of plug pins 0.5 mm ² , 4-pole (lagging DC)	1	–	X	–	GHG 570 1904 R0011
Set of plug pins 1.5 mm ² , 3-pole + PE (PE leading AC)	1	X	–	–	GHG 570 1904 R0003
Set of plug pins 1.5 mm ² , 4-pole (lagging DC)	1	–	X	–	GHG 570 1904 R0001
Set of plug pins 2.5 mm ² , 3-pole + PE (PE leading AC)	1	X	–	–	GHG 570 1904 R0004
Set of plug pins 2.5 mm ² , 4-pole (lagging DC)	1	–	X	–	GHG 570 1904 R0002
Set of plug pins 1.5 mm ² , 4-pole + PE-spring clip	1	–	–	X	GHG 570 1904 R0005
Set of plug pins 2.5 mm ² , 4-pole + PE-spring clip	1	–	–	X	GHG 570 1904 R0006
Scew driver for cage clamp	1	X	X	–	GHG 570 1908 R0001
Strain relief and seal 4 - 7.5 mm	1	X	X	X	GHG 570 1907 R0001
Strain relief and seal 7.5 - 11 mm	1	X	X	X	GHG 570 1907 R0002
Anti torsion device	1	X	X	X	GHG 570 1901 R0001

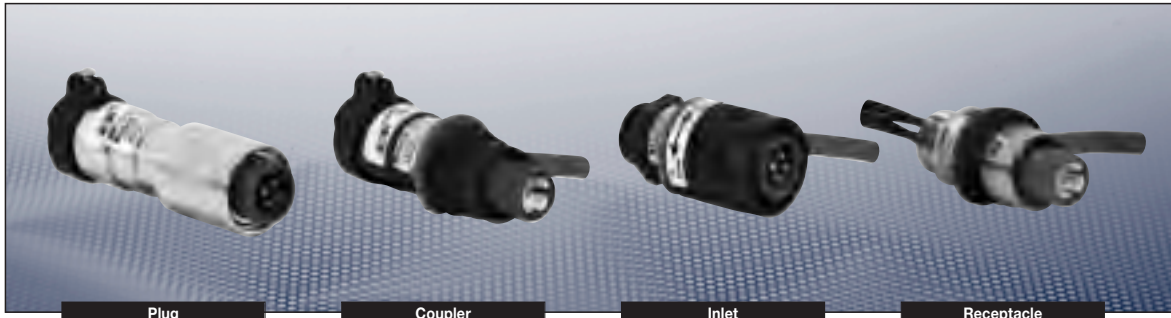

Dimension drawing eXLink

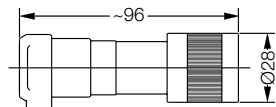

Plug metal version

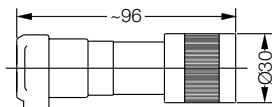

Plug plastic version

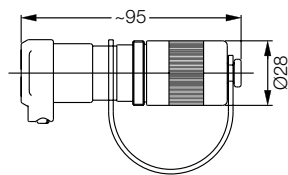

Coupler metal version

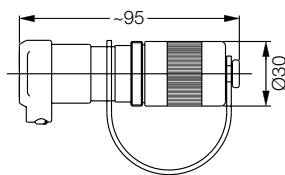

Coupler plastic version

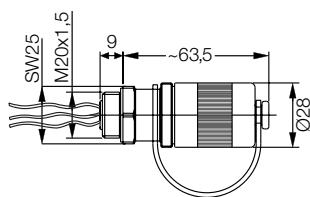

Receptacle metal version

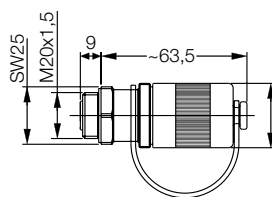

Receptacle plastic version

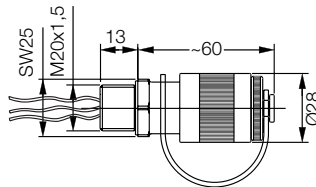

Inlet metal version: V < 2000 cm³

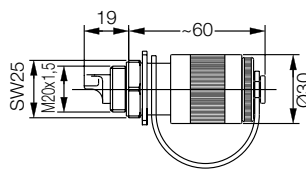

Inlet plastic version

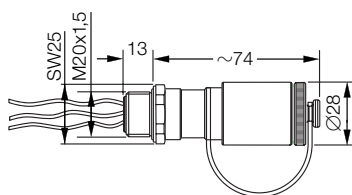

Inlet metal version: V > 2000 cm³

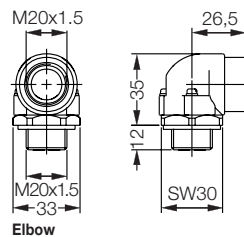

Elbow

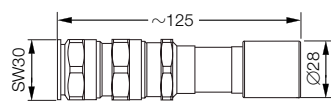

Plug for armoured cable

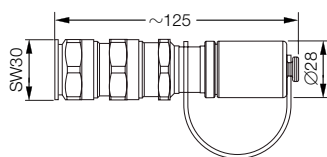

Coupler for armoured cable

Dimensions in mm