

# Emergency Luminaire Aluminium Enclosure 79011 CG-S 79021 CG-S



79011 CG-S









79021 CG-S DM

## Technical Data

### 79011 CG-S / 79021 CG-S

<b>Viewing distance</b>		<b>60 m</b>
Enclosure Material		Aluminium
Weight incl. cover	79011 CG-S	3.55 kg
	79021 CG-S	3.00 kg
Enclosure colour		Aluminium, anodized
	79011 CG-S	Wall mounting
Type of mounting	79021 CG-S	Wall and ceiling mounting
Dimensions in mm (L x H x D)	79011 CG-S	636 x 335 x 80
	79021 CG-S	636 x 335 x 80
Connection terminals		Loop terminals 3 x 2.5 mm <sup>2</sup>
Voltage ranges		230 V 50/60 Hz, 220 V DC +25/-20 %
Current consumption		70 mA
Power consumption		32,2 VA
Permissible temperature range		-10°C to + 40°C
Lamp		18 W/T26, 1350 lm
Insulation class		I
Degree of protection		IP 40

## Ordering details

Type	Scope of supply	Order No.
<b>79011 CG-S</b>	<b>Luminaire with CEWA GUARD monitoring and 20-digit address switch, without cover and lamp</b>	<b>400 71 351 230</b>
<b>Cover SL</b>	<b>Clear cover</b>	<b>400 71 351 189</b>
<b>79021* CG-S WM</b>	<b>Luminaire with CEWA GUARD monitoring for wall mounting, with 20-digit address switch, without cover and lamp</b>	<b>400 71 351 231</b>
<b>79021* CG-S DM</b>	<b>Luminaire with CEWA GUARD monitoring for ceiling mounting, with 20-digit address switch, without cover and lamp</b>	<b>400 71 351 232</b>
<b>79021* CG-S PM</b>	<b>Luminaire with CEWA GUARD monitoring for pendulum mounting, with 20-digit address switch, without cover and lamp</b>	<b>400 71 351 233</b>
<b>Cover PL</b>	<b>Cover with silk screende legend acc. DIN 4844</b> 	<b>400 71 351 800</b>
<b>Cover PR</b>	<b>Cover with silk screende legend acc. DIN 4844</b> 	<b>400 71 351 801</b>
<b>Cover PU</b>	<b>Cover with silk screende legend acc. DIN 4844</b> 	<b>400 71 351 802</b>
<b>Cover PL</b>	<b>Cover with silk screende legend</b> 	<b>400 71 351 808</b>
<b>Cover PR</b>	<b>Cover with silk screende legend</b> 	<b>400 71 351 809</b>
<b>Cover PU</b>	<b>Cover with silk screende legend</b> 	<b>400 71 351 810</b>
<b>Dummy cover</b>		<b>400 71 351 199</b>

\* Each luminaire requires 2 covers.

Installation material is not included in the scope of delivery of the luminaire. Please order installation material separately depending on the type of mounting (see accessories).

DM = ceiling mounting, WM = wall mounting, PM = pendulum mounting

## Accessories

Type	Scope of supply	Order No.
Mounting kit for wall and ceiling mounting*	for WM / DM rectangular 42 mm	400 71 351 011
Mounting kit for wall and ceiling mounting*	for WM / DM rectangular 100 mm	400 71 351 497
Mounting kit for wall and ceiling mounting*	for WM / DM rectangular 500 mm	400 71 351 498
Pendulum set 0.5 m	with canopy, silver, square form, for PM	400 71 344 599
Pendulum set 1.0 m	with canopy, silver, square form, for PM	400 71 350 775
Pendulum set 1.5 m	with canopy, silver, square form, for PM	400 71 350 776
Chain fastening	for 79021, 79021 CG-S	400 71 351 158

\*two mounting kits per luminaire are necessary

# Emergency Luminaire Aluminium Enclosure 79011 CG-S 79021 CG-S

## Lighting engineering (with 18 W/T26, 1350 lm lamp)

Measuring level: 0,02 m, incl. 25% ageing factor

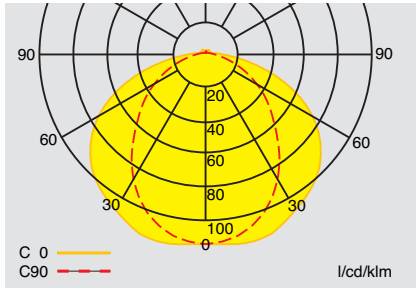

Polar curve 79011 CG-S

### Engineering help 79011 CG-S, with clear cover for E = 1,25 lx (0,625 lx)

Mounting height (m)	Type of mounting	Mounting distances (m)			
		L1	L2	L3	L4
2.5	Ceiling mounting	3.7 (4.5)	9.0 (10.8)	4.7 (5.8)	11.6 (14.0)
3.0	Escape route centre	4.0 (4.9)	9.8 (12.0)	5.1 (6.3)	12.6 (15.2)
4.0		4.3 (5.5)	11.0 (13.6)	5.5 (7.0)	14.0 (17.4)
5.0		4.5 (6.0)	11.8 (15.0)	5.8 (7.6)	15.2 (19.0)
6.0		4.6 (6.2)	12.4 (16.0)	5.8 (7.9)	15.8 (20.4)
7.0		4.5 (6.4)	12.6 (16.8)	5.6 (8.1)	16.2 (21.4)
2.0	Wall mounting	2.8 (3.3)	6.6 (7.8)	3.2 (3.9)	7.8 (9.6)
2.5		2.8 (3.4)	6.8 (8.2)	3.0 (3.9)	7.8 (9.6)
3.0		2.7 (3.4)	6.8 (8.4)	2.6 (3.7)	7.4 (9.6)
3.0	Ceiling mounting	3.4 (4.4)	9.6 (10.8)	4.5 (5.5)	10.6 (13.6)
4.0	Area illumination	3.4 (4.4)	11.2 (13.4)	5.5 (6.5)	11.8 (14.6)
5.0		4.4 (4.4)	11.2 (14.2)	4.5 (7.5)	14.2 (17.0)
6.0		4.4 (5.4)	12.8 (15.0)	4.5 (6.5)	14.2 (18.8)
7.0		3.4 (5.4)	13.2 (17.0)	5.5 (6.5)	15.2 (18.8)

### Dimensions (mm)

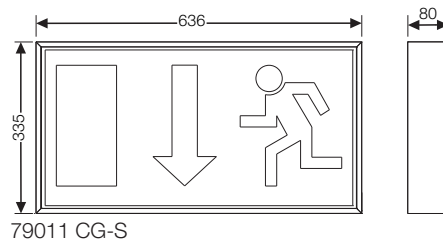

79011 CG-S

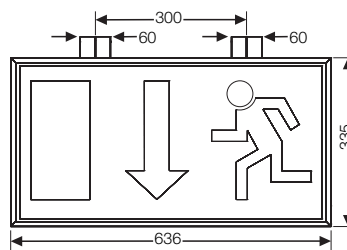

79021 CG-S DM

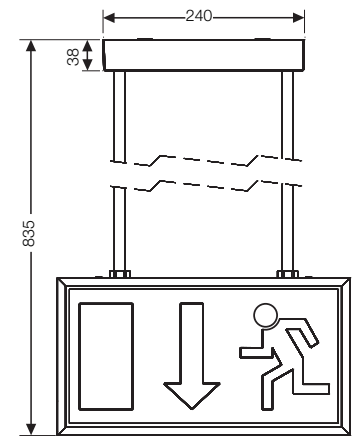

79021 CG-S PM

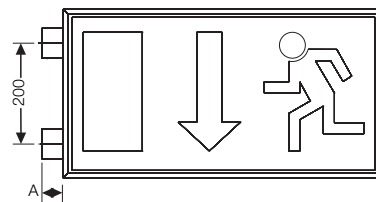

79021 CG-S WM

A = 42 mm, 100 mm and 500 mm