







Emergency Luminaire STYLE 57011 CG-S

Technical data

57011 CG-S

Viewing distance with legend	32 m
Luminous flux Φ_E/Φ_N at the end of rated operating time	75 %
Enclosure material	Polycarbonate
Weight incl. cover	0,85 kg
Enclosure colour	Grey with coloured design elements
Design elements	RAL 5022 night blue RAL 7015 slate grey
Type of mounting	Wall and ceiling mounting
Dimensions (mm) (L x H x D)	370 x 225 x 60
Connection terminals	Loop terminals 3 x 2.5 mm ²
Voltage ranges	230 V 50/60 Hz, 220 V DC +25/-20%
Current consumption (220 V battery)	30 mA
Power consumption	16 VA
Permissible temperature range	-10°C to + 40°C
Lamp	8 W/T16, 450 lm
Insulation class	II
Degree of protection	IP 41 (IP 54 kit for electronics and lamp, optional)

Ordering details

Type	Scope of supply	Order No.
57011 CG-S, RAL 5022	Luminaire enclosure without cover, without quick mounting, night blue, with CEWA GUARD-monitoring and 20 digit address switch	4 0071 345 957
57011 CG-S, RAL 7015	Luminaire enclosure without cover, without quick mounting, slate grey, with CEWA GUARD-monitoring and 20 digit address switch	4 0071 345 955
Cover SL	Clear cover	4 0071 345 985
Opaque cover	Opaque cover	4 0071 345 986
Structured cover	Structured cover	4 0071 348 223
Cover PL acc. DIN 4844	Cover with silk screened legend 	4 0071 349 320
Cover PR acc. DIN 4844	Cover with silk screened legend 	4 0071 349 321
Cover PU acc. DIN 4844	Cover with silk screened legend 	4 0071 349 323
Cover PL	Cover with silk screened legend 	4 0071 348 011
Cover PR	Cover with silk screened legend 	4 0071 348 012
Cover PU	Cover with silk screened legend 	4 0071 348 013
Quick-mounting set	Quick-mounting set with terminals and distance plates	4 0071 345 980

Accessories

Accessories see page 1/20



57011 CG-S
with clear cover



57011 CG-S
with cover PL



57011 CG-S
with clear cover, silk screened structure



57011 CG-S with opaque cover

Dimensions (mm)

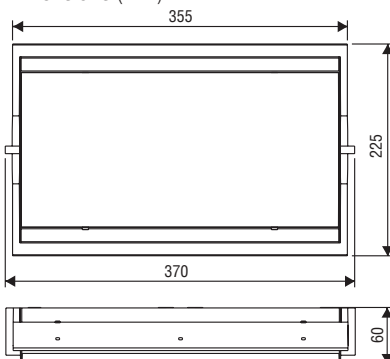

Emergency Luminaire STYLE 57011 CG-S

Lighting engineering (with 8 W/T16, 450 lm lamp)

Measuring level: 0.02 m, incl. 25% ageing factor

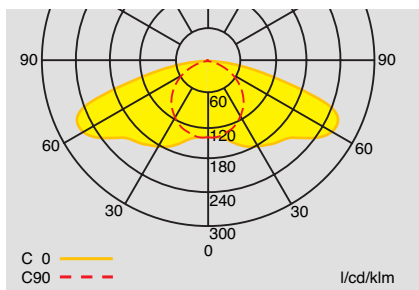

**Polar curve 57011 CG-S
with clear cover**

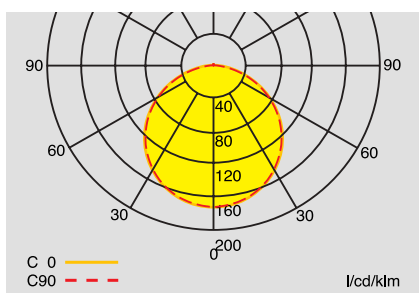

**Polar curve 57011 CG-S
with opaque cover**

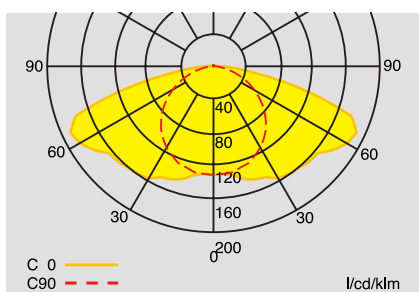

**Polar curve 57011 CG-S
with clear cover, silk screened structure**

Engineering help 57011 CG-S with clear cover for E = 1.25 lx (0.625 lx)

Mounting height (m)	Types of mounting	Mounting distances (m)			
		L1	L2	L3	L4
2.5	Ceiling mounting	2.9 (3.7)	7.4 (9.0)	5.1 (6.4)	12.6 (15.0)
3.0	Escape route centre	3.1 (4.0)	7.8 (9.8)	5.2 (6.8)	13.6 (16.6)
4.0		3.0 (4.3)	8.6 (11.0)	5.1 (7.4)	14.6 (16.8)
5.0		2.7 (4.3)	8.6 (11.8)	4.4 (7.4)	14.8 (20.4)
6.0		2.0 (4.2)	8.2 (12.2)	3.6 (6.8)	13.6 (21.0)
7.0		0.1 (3.8)	7.4 (12.2)	0.6 (6.2)	12.2 (20.8)
2.0	Wall mounting	2.8 (3.4)	6.8 (7.8)	3.3 (4.1)	8.0 (9.8)
2.5		2.9 (3.5)	7.0 (8.2)	3.1 (4.0)	8.0 (10.0)
3.0		2.8 (3.5)	7.0 (8.4)	0.1 (3.9)	7.6 (9.8)
3.0	Ceiling mounting	2.4 (3.4)	7.8 (9.8)	5.5 (6.5)	13.8 (16.2)
4.0	Area illumination	2.8 (3.4)	8.6 (11.0)	4.1 (7.5)	15.4 (19.0)
5.0		2.4 (4.4)	8.8 (11.8)	4.5 (5.5)	16.2 (21.0)
6.0		1.8 (3.4)	9.0 (12.2)	2.9 (6.5)	15.8 (22.4)
7.0		0.7 (3.4)	8.8 (12.6)	0.7 (5.5)	14.8 (22.8)

Engineering help 57011 CG-S with opaque cover for E = 1.25 lx (0.625 lx)

Mounting height (m)	Types of mounting	Mounting distances (m)			
		L1	L2	L3	L4
2.5	Ceiling mounting	3.2 (4.0)	8.0 (9.8)	3.2 (4.0)	8.0 (9.8)
3.0	Escape route centre	3.3 (4.3)	8.6 (10.6)	3.3 (4.3)	8.6 (10.6)
4.0		3.4 (4.6)	9.2 (11.8)	3.4 (4.7)	9.2 (12.0)
5.0		3.1 (4.7)	9.4 (12.6)	3.2 (4.8)	9.4 (12.8)
6.0		2.5 (4.7)	9.2 (13.2)	2.6 (4.7)	9.4 (13.2)
7.0		1.4 (4.4)	8.6 (13.2)	1.5 (4.4)	8.6 (13.4)
2.0	Wall mounting	2.0 (2.6)	5.2 (6.6)	2.1 (2.7)	5.4 (6.8)
2.5		1.8 (2.5)	5.0 (6.6)	1.7 (2.6)	5.0 (6.8)
3.0		1.3 (2.3)	4.6 (6.4)	1.0 (2.2)	4.4 (6.4)
3.0	Ceiling mounting	2.4 (3.5)	7.4 (9.2)	3.5 (3.4)	7.4 (9.0)
4.0	Area illumination	2.4 (3.4)	8.4 (10.4)	3.5 (4.5)	8.2 (10.2)
5.0		2.4 (3.4)	8.8 (11.4)	3.5 (4.5)	9.0 (11.2)
6.0		2.4 (3.4)	9.2 (12.0)	2.5 (4.5)	9.2 (12.0)
7.0		0.7 (3.4)	9.4 (12.4)	0.7 (4.5)	9.2 (12.6)

Engineering help 57011 CG-S with clear cover, silk screened structure for E = 1.25 lx (0.625 lx)

Mounting height (m)	Types of mounting	Mounting distances (m)			
		L1	L2	L3	L4
2.5	Ceiling mounting	2.7 (3.4)	6.8 (8.6)	4.0 (5.4)	10.8 (13.4)
3	Escape route centre	2.7 (3.7)	7.2 (9.2)	4.0 (5.6)	11.2 (14.4)
4		2.6 (3.8)	7.6 (10.2)	3.7 (5.7)	11.2 (15.8)
5		2.0 (3.8)	7.6 (10.6)	3.1 (5.3)	10.6 (16.0)
6		0.5 (3.5)	6.8 (10.8)	1.1 (4.9)	9.6 (15.6)
7		0.1 (2.8)	5.2 (10.6)	0.1 (4.3)	8.0 (14.8)
2	Wall mounting	2.6 (3.2)	6.4 (7.6)	2.8 (3.5)	7.0 (8.6)
2.5		2.6 (3.3)	6.6 (7.8)	2.7 (3.5)	6.8 (8.6)
3		2.4 (3.2)	6.4 (8.0)	0.1 (3.3)	6.6 (8.4)
3	Ceiling mounting	2.6 (3.5)	7.2 (9.2)	3.3 (4.4)	11.6 (14.2)
4	Area illumination	2.4 (3.6)	7.8 (10.2)	3.5 (4.3)	12.0 (16.0)
5		1.8 (3.4)	8.2 (10.8)	2.6 (4.5)	11.6 (17.0)
6		0.7 (2.4)	8.0 (11.2)	0.7 (5.5)	11.2 (17.0)
7		0.7 (2.4)	6.8 (11.6)	0.7 (3.5)	11.2 (16.4)

Emergency Luminaire STYLE 57021 CG-S









57021 CG-S with cover PU
and pendulum set

Technical data

57021 CG-S

Viewing distance with legend	32 m
Luminous flux Φ_E/Φ_N at the end of rated operating time	75 %
Enclosure material	Polycarbonate
Weight incl. cover	1.25 kg
Enclosure colour	Grey with coloured design elements
Design elements	RAL 5022 night blue RAL 7015 slate grey
Type of mounting	Ceiling mounting
Dimensions (mm) (L x H x D)	370 x 225 x 118
Connection terminals	Loop terminals 3 x 2.5 mm ²
Voltage ranges	230 V 50/60 Hz, 220 V DC +25/-20%
Current consumption (220 V battery)	30 mA
Power consumption	16 VA
Permissible temperature range lamp	-10°C to + 40°C
Insulation class	II
Degree of protection	IP 41 (IP 54 kit for electronics and lamp, optional)

Ordering details

Type	Scope of supply	Order No.
57021 CG-S, RAL 5022	Luminaire enclosure without cover, without quick-mounting set, night blue, with CEWA GUARD monitoring and 20 digit address switch	4 0071 345 958
57021 CG-S, RAL 7015	Luminaire enclosure without cover, without quick-mounting set, slate grey, with CEWA GUARD monitoring and 20 digit address switch	4 0071 345 956
Cover SL	Clear cover	4 0071 345 985
Opaque cover	Opaque cover	4 0071 345 986
Dummy cover	Dummy cover	4 0071 345 987
Structured cover	Structured cover	4 0071 348 223
Cover PL acc. DIN 4844	Cover with silk screened legend 	4 0071 349 320
Cover PR acc. DIN 4844	Cover with silk screened legend 	4 0071 349 321
Cover PU acc. DIN 4844	Cover with silk screened legend 	4 0071 349 323
Cover PL	Cover with silk screened legend 	4 0071 348 011
Cover PR	Cover with silk screened legend 	4 0071 348 012
Cover PU	Cover with silk screened legend 	4 0071 348 013
Quick-mounting set	Quick-mounting set with terminals and distance plates	4 0071 345 980

Accessories

Accessories see page 1/20



Colour of desing elements: night blue

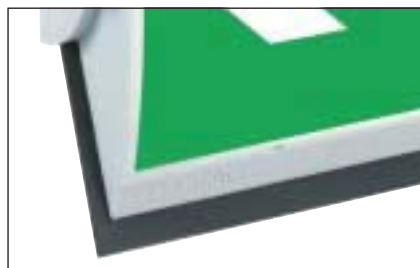

Colour of desing elements: slate grey

Dimensions (mm)

